

# PMEG3015EH; PMEG3015EJ

30 V, 1.5 A ultra low  $V_F$  MEGA Schottky barrier rectifiers

Rev. 02 — 8 April 2005

Product data sheet

## 1. Product profile

### 1.1 General description

Planar Maximum Efficiency General Application (MEGA) Schottky barrier rectifiers with an integrated guard ring for stress protection, encapsulated in small and flat lead SMD plastic packages.

Table 1: Product overview

Type number	Package		Configuration
	Philips	JEITA	
PMEG3015EH	SOD123F	-	single diode
PMEG3015EJ	SOD323F	SC-90	single diode

### 1.2 Features

- Forward current:  $\leq 1.5$  A
- Reverse voltage:  $\leq 30$  V
- Ultra low forward voltage
- Small and flat lead SMD plastic packages

### 1.3 Applications

- Low voltage rectification
- High efficiency DC-to-DC conversion
- Switch mode power supply
- Inverse polarity protection
- Low power consumption applications

### 1.4 Quick reference data

Table 2: Quick reference data



Symbol	Parameter	Conditions	Min	Typ	Max	Unit
$I_F$	forward current	$T_{sp} \leq 55$ °C	-	-	1.5	A
$V_R$	reverse voltage		-	-	30	V
$V_F$	forward voltage	$I_F = 1.5$ A	[1] -	440	550	mV

[1] Pulse test:  $t_p \leq 300$   $\mu$ s;  $\delta \leq 0.02$ .

**PHILIPS**

## 2. Pinning information

**Table 3: Pinning**

Pin	Description	Simplified outline	Symbol
1	cathode	 001aab540	 sym001
2	anode		

[1] The marking bar indicates the cathode.

## 3. Ordering information

**Table 4: Ordering information**

Type number	Package		
	Name	Description	Version
PMEG3015EH	-	plastic surface mounted package; 2 leads	SOD123F
PMEG3015EJ	SC-90	plastic surface mounted package; 2 leads	SOD323F

## 4. Marking

**Table 5: Marking codes**

Type number	Marking code
PMEG3015EH	AE
PMEG3015EJ	EK

## 5. Limiting values

**Table 6: Limiting values**

In accordance with the Absolute Maximum Rating System (IEC 60134).

Symbol	Parameter	Conditions	Min	Max	Unit
$V_R$	reverse voltage		-	30	V
$I_F$	forward current	$T_{sp} \leq 55\text{ °C}$	-	1.5	A
$I_{FRM}$	repetitive peak forward current	$t_p \leq 1\text{ ms}; \delta \leq 0.25$	-	4.5	A
$I_{FSM}$	non-repetitive peak forward current	square wave; $t_p = 8\text{ ms}$	-	9	A
$P_{tot}$	total power dissipation	$T_{amb} \leq 25\text{ °C}$	[1] -	375	mW
			[2] -	830	mW
	PMEG3015EJ	[1] -	360	mW	
		[2] -	830	mW	
$T_j$	junction temperature		-	150	°C

**Table 6: Limiting values ...continued**

In accordance with the Absolute Maximum Rating System (IEC 60134).

Symbol	Parameter	Conditions	Min	Max	Unit
$T_{amb}$	ambient temperature		-65	+150	°C
$T_{stg}$	storage temperature		-65	+150	°C

[1] Device mounted on an FR4 Printed-Circuit Board (PCB), single-sided copper, tin-plated and standard footprint.

[2] Device mounted on an FR4 PCB, single-sided copper, tin-plated, mounting pad for cathode 1 cm<sup>2</sup>.

## 6. Thermal characteristics

**Table 7: Thermal characteristics**

Symbol	Parameter	Conditions	Min	Typ	Max	Unit		
$R_{th(j-a)}$	thermal resistance from junction to ambient	in free air						
			PMEG3015EH	[1] [2]	-	-	330	K/W
				[2] [3]	-	-	150	K/W
			PMEG3015EJ	[1] [2]	-	-	350	K/W
			[2] [3]	-	-	150	K/W	
$R_{th(j-sp)}$	thermal resistance from junction to solder point							
		PMEG3015EH		-	-	60	K/W	
		PMEG3015EJ		-	-	55	K/W	

[1] Device mounted on an FR4 PCB, single-sided copper, tin-plated and standard footprint.

[2] For Schottky barrier diodes thermal run-away has to be considered, as in some applications the reverse power losses  $P_R$  are a significant part of the total power losses. Nomograms for determining the reverse power losses  $P_R$  and  $I_{F(AV)}$  rating are available on request.

[3] Device mounted on an FR4 PCB, single-sided copper, tin-plated, mounting pad for cathode 1 cm<sup>2</sup>.

## 7. Characteristics

**Table 8: Characteristics**

$T_{amb} = 25\text{ °C}$  unless otherwise specified.

Symbol	Parameter	Conditions	Min	Typ	Max	Unit	
$V_F$	forward voltage	$I_F = 1\text{ mA}$	[1]	-	125	160	mV
		$I_F = 10\text{ mA}$	[1]	-	185	220	mV
		$I_F = 100\text{ mA}$	[1]	-	255	290	mV
		$I_F = 500\text{ mA}$	[1]	-	330	380	mV
		$I_F = 1\text{ A}$	[1]	-	400	480	mV
		$I_F = 1.5\text{ A}$	[1]	-	440	550	mV
$I_R$	reverse current	$V_R = 10\text{ V}$		-	60	150	μA
		$V_R = 30\text{ V}$		-	400	1000	μA
$C_d$	diode capacitance	$V_R = 1\text{ V}; f = 1\text{ MHz}$		-	60	72	pF

[1] Pulse test:  $t_p \leq 300\text{ }\mu\text{s}$ ;  $\delta \leq 0.02$ .

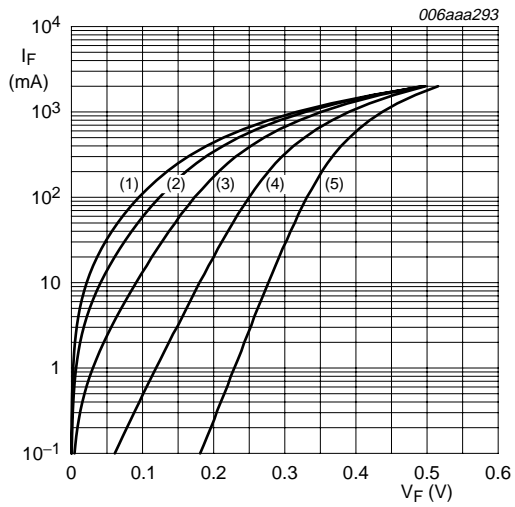

- (1)  $T_{amb} = 150\text{ }^{\circ}\text{C}$
- (2)  $T_{amb} = 125\text{ }^{\circ}\text{C}$
- (3)  $T_{amb} = 85\text{ }^{\circ}\text{C}$
- (4)  $T_{amb} = 25\text{ }^{\circ}\text{C}$
- (5)  $T_{amb} = -40\text{ }^{\circ}\text{C}$

**Fig 1. Forward current as a function of forward voltage; typical values**

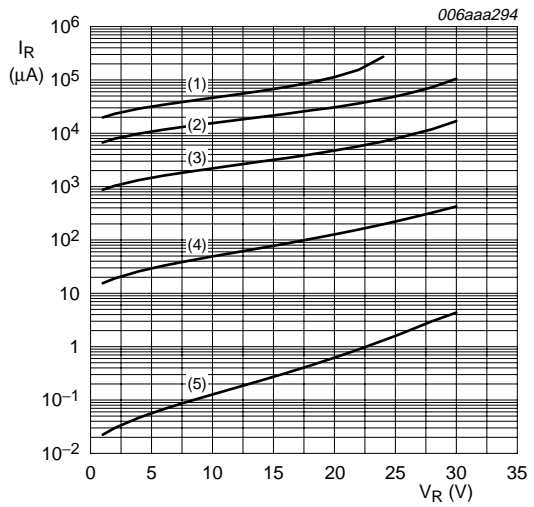

- (1)  $T_{amb} = 150\text{ }^{\circ}\text{C}$
- (2)  $T_{amb} = 125\text{ }^{\circ}\text{C}$
- (3)  $T_{amb} = 85\text{ }^{\circ}\text{C}$
- (4)  $T_{amb} = 25\text{ }^{\circ}\text{C}$
- (5)  $T_{amb} = -40\text{ }^{\circ}\text{C}$

**Fig 2. Reverse current as a function of reverse voltage; typical values**

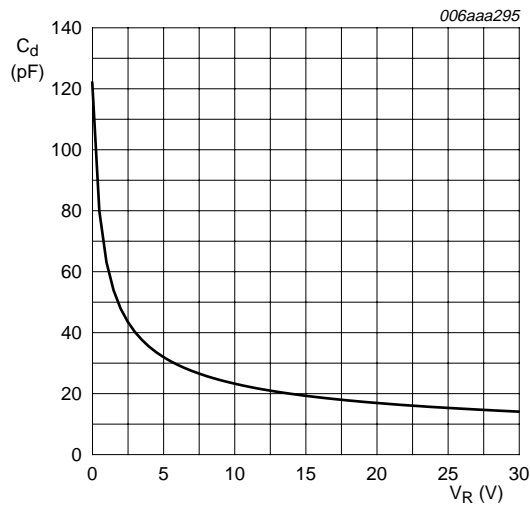

$T_{amb} = 25\text{ }^{\circ}\text{C}; f = 1\text{ MHz}$

**Fig 3. Diode capacitance as a function of reverse voltage; typical values**

## 8. Package outline

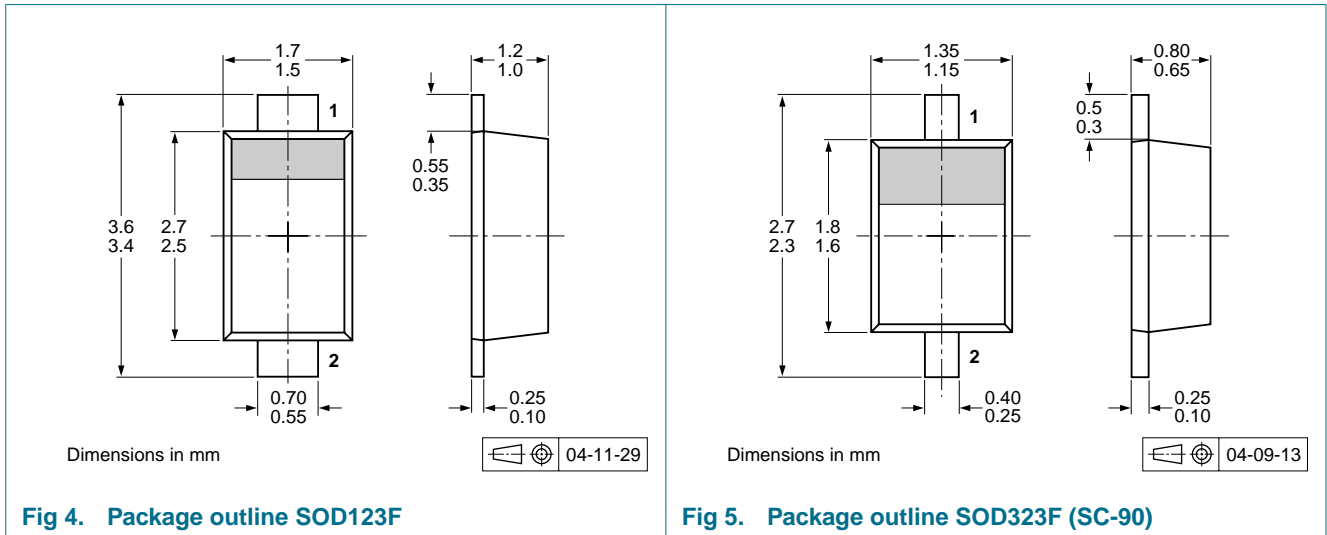

## 9. Packing information

**Table 9: Packing methods**

The indicated -xxx are the last three digits of the 12NC ordering code. [1]

Type number	Package	Description	Packing quantity	
			3000	10000
PMEG3015EH	SOD123F	4 mm pitch, 8 mm tape and reel	-115	-135
PMEG3015EJ	SOD323F			

[1] For further information and the availability of packing methods, see [Section 15](#).

**10. Soldering**

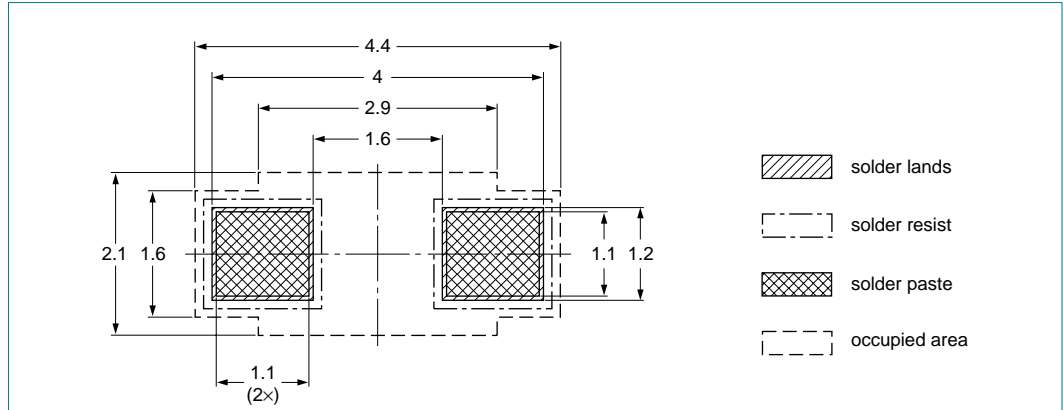

Reflow soldering is the only recommended soldering method.

Dimensions in mm

**Fig 6. Reflow soldering footprint SOD123F**

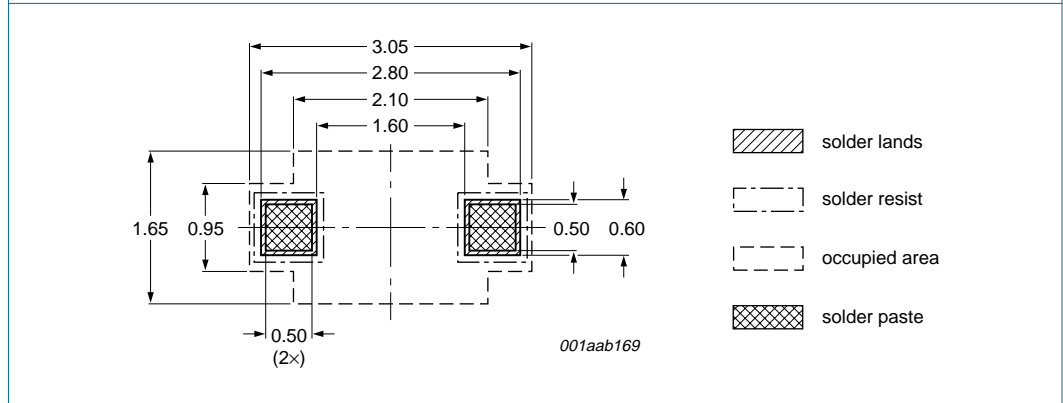

Reflow soldering is the only recommended soldering method.

Dimensions in mm

**Fig 7. Reflow soldering footprint SOD323F (SC-90)**

## 11. Revision history

**Table 10: Revision history**

Document ID	Release date	Data sheet status	Change notice	Doc. number	Supersedes
PMEG3015EH_EJ_2	20050408	Product data sheet	-	9397 750 14917	PMEG3015EJ_1
Modifications:	• Type PMEG3015EH added				
PMEG3015EJ_1	20050303	Product data sheet	-	9397 750 14516	-

## 12. Data sheet status

Level	Data sheet status <sup>[1]</sup>	Product status <sup>[2]</sup> <sup>[3]</sup>	Definition
I	Objective data	Development	This data sheet contains data from the objective specification for product development. Philips Semiconductors reserves the right to change the specification in any manner without notice.
II	Preliminary data	Qualification	This data sheet contains data from the preliminary specification. Supplementary data will be published at a later date. Philips Semiconductors reserves the right to change the specification without notice, in order to improve the design and supply the best possible product.
III	Product data	Production	This data sheet contains data from the product specification. Philips Semiconductors reserves the right to make changes at any time in order to improve the design, manufacturing and supply. Relevant changes will be communicated via a Customer Product/Process Change Notification (CPCN).

[1] Please consult the most recently issued data sheet before initiating or completing a design.

[2] The product status of the device(s) described in this data sheet may have changed since this data sheet was published. The latest information is available on the Internet at URL <http://www.semiconductors.philips.com>.

[3] For data sheets describing multiple type numbers, the highest-level product status determines the data sheet status.

## 13. Definitions

**Short-form specification** — The data in a short-form specification is extracted from a full data sheet with the same type number and title. For detailed information see the relevant data sheet or data handbook.

**Limiting values definition** — Limiting values given are in accordance with the Absolute Maximum Rating System (IEC 60134). Stress above one or more of the limiting values may cause permanent damage to the device. These are stress ratings only and operation of the device at these or at any other conditions above those given in the Characteristics sections of the specification is not implied. Exposure to limiting values for extended periods may affect device reliability.

**Application information** — Applications that are described herein for any of these products are for illustrative purposes only. Philips Semiconductors make no representation or warranty that such applications will be suitable for the specified use without further testing or modification.

## 14. Disclaimers

**Life support** — These products are not designed for use in life support appliances, devices, or systems where malfunction of these products can reasonably be expected to result in personal injury. Philips Semiconductors customers using or selling these products for use in such applications do so at their own risk and agree to fully indemnify Philips Semiconductors for any damages resulting from such application.

**Right to make changes** — Philips Semiconductors reserves the right to make changes in the products - including circuits, standard cells, and/or software - described or contained herein in order to improve design and/or performance. When the product is in full production (status 'Production'), relevant changes will be communicated via a Customer Product/Process Change Notification (CPCN). Philips Semiconductors assumes no responsibility or liability for the use of any of these products, conveys no license or title under any patent, copyright, or mask work right to these products, and makes no representations or warranties that these products are free from patent, copyright, or mask work right infringement, unless otherwise specified.

## 15. Contact information

For additional information, please visit: <http://www.semiconductors.philips.com>

For sales office addresses, send an email to: [sales.addresses@www.semiconductors.philips.com](mailto:sales.addresses@www.semiconductors.philips.com)



## 16. Contents

---

<b>1</b>	<b>Product profile</b> .....	<b>1</b>
1.1	General description .....	1
1.2	Features .....	1
1.3	Applications .....	1
1.4	Quick reference data .....	1
<b>2</b>	<b>Pinning information</b> .....	<b>2</b>
<b>3</b>	<b>Ordering information</b> .....	<b>2</b>
<b>4</b>	<b>Marking</b> .....	<b>2</b>
<b>5</b>	<b>Limiting values</b> .....	<b>2</b>
<b>6</b>	<b>Thermal characteristics</b> .....	<b>3</b>
<b>7</b>	<b>Characteristics</b> .....	<b>3</b>
<b>8</b>	<b>Package outline</b> .....	<b>5</b>
<b>9</b>	<b>Packing information</b> .....	<b>5</b>
<b>10</b>	<b>Soldering</b> .....	<b>6</b>
<b>11</b>	<b>Revision history</b> .....	<b>7</b>
<b>12</b>	<b>Data sheet status</b> .....	<b>8</b>
<b>13</b>	<b>Definitions</b> .....	<b>8</b>
<b>14</b>	<b>Disclaimers</b> .....	<b>8</b>
<b>15</b>	<b>Contact information</b> .....	<b>8</b>



© Koninklijke Philips Electronics N.V. 2005

All rights are reserved. Reproduction in whole or in part is prohibited without the prior written consent of the copyright owner. The information presented in this document does not form part of any quotation or contract, is believed to be accurate and reliable and may be changed without notice. No liability will be accepted by the publisher for any consequence of its use. Publication thereof does not convey nor imply any license under patent- or other industrial or intellectual property rights.

Date of release: 8 April 2005  
Document number: 9397 750 14917

Published in The Netherlands